

# Building Regulations 1997

## Technical Guidance Document C

### Site Preparation and Resistance to Moisture

---

BAILE ÁTHA CLIATH:  
ARNA FHOILSIÚ AG OIFIG AN tSOLÁTHAIR

---

Le ceannach díreach ón  
OIFIG DHÍOLTA TA FOILSEACHÁN RIALTAIS,  
TEACH SUN ALLIANCE, SRÁID THEACH LAIGHEAN, BAILE ÁTHA CLIATH 2,  
nó tríd an bpost ó  
51 FAICHE STIABHNA  
BAILE ÁTHA CLIATH 2,  
(Teil: 01-6476000, FaICS: 01- 6476843)  
nó trí aon díoltóir leabhar.

---

DUBLIN  
PUBLISHED BY THE STATIONERY OFFICE

---

To be purchased from the  
GOVERNMENT PUBLICATIONS SALE OFFICE,  
SUN ALLIANCE HOUSE, MOLESWORTH STREET, DUBLIN 2.  
or by mail order from  
MAIL ORDER SECTION,  
51 ST. STEPHEN'S GREEN, DUBLIN 2,  
(Tel: 01-6476000; Fax: 01-6476843)  
or through any bookseller.  
Price: €7.00



Comhshaol, Oidhreacht agus Rialtas Áitiúil  
Environment, Heritage and Local Government

© Government of Ireland 2008

# Amendments issued since publication

## Technical Guidance Document C Site Preparation and Resistance to Moisture

September 2004 Edition

<b>Amd. No.</b>	<b>Text Affected</b>
C (i) Item 3.1.4 (b)	<p>The hardcore bed should be at least 150 mm thick. Hardcore should conform with I.S. EN 13242:2002 and meet the specification as outlined in Annex E of the accompanying guidance document to this standard, SR21: 2004+A1: 2007. The layer of hardcore should be well compacted, clean and free from matter liable to cause damage to the concrete. Specific guidance is given in 3.4.2 of SR21: 2004+A1: 2007 on limiting the presence of a reactive form of pyrite which may give rise to swelling or sulfate attack on concrete.</p> <p>A blinding layer should be provided in accordance with the specification given in Annex E, of SR21: 2004+A1: 2007, for fines material. The blinding layer should be of adequate depth to fill surface voids thus creating an even surface and avoiding sharp projections, which may damage radon or damp-proof membranes.</p>
C (ii) Standards and other References;	<p>I.S. EN 13242:2002 Aggregates for unbound and hydraulically bound materials for use in civil engineering work and road construction</p> <p>SR21: 2004+A1: 2007 Guidance on the use of I.S. EN 13242:2002 - aggregates for unbound and hydraulically bound materials for use in civil engineering work and road construction (Incorporating Amendment 1:2007).</p>



# Contents

---

	Page
Introduction	2
Transitional Arrangements	
The Guidance	
Existing Buildings	
Technical Specifications	
Materials and Workmanship	
Interpretation	
<b>Part C : The Requirement</b>	<b>4</b>
<b>Section 1</b>	
<b>SITE PREPARATION AND SITE DRAINAGE</b>	<b>5</b>
Organic material	
Site drainage	
<b>Section 2</b>	
<b>DANGEROUS SUBSTANCES</b>	<b>7</b>
Investigation of site	
Remedial measures	
Radon	8
Landfill gas	10
RPII Radon Prediction Maps	11
<b>Section 3</b>	
<b>RESISTANCE TO WEATHER AND GROUND MOISTURE</b>	<b>16</b>
Introduction	
<b>Sub-section 3.1</b>	
<b>Floors next to the ground</b>	
Ground supported floors	16
Suspended timber ground floors	18
Suspended concrete ground floors	19
<b>Sub-section 3.2</b>	
<b>Walls</b>	
External and Internal walls- Moisture from the ground	20
External walls - Moisture from outside	
<b>Sub-section 3.3</b>	<b>21</b>
<b>Cladding for external walls and roofs</b>	
<b>STANDARDS AND OTHER REFERENCES</b>	<b>23</b>

---

# Building Regulations, 1997

## Technical Guidance Document C

### Site Preparation and Resistance to Moisture

---

#### Introduction

This document has been published by the Minister for the Environment, Heritage and Local Government under article 7 of the Building Regulations, 1997. It provides guidance in relation to Part C of the Second Schedule to the Regulations. The document should be read in conjunction with the Building Regulations, 1997, and other documents published under these Regulations.

In general, Building Regulations apply to the construction of new buildings and to extensions and material alterations to existing buildings. In addition, certain parts of the Regulations apply to existing buildings where a material change of use takes place, in relation to Part C, only requirement C4 applies. Otherwise, Building Regulations do not apply to buildings constructed prior to 1 June, 1992.

This edition of Technical Guidance Document C amends and updates the guidance in relation to Radon prevention in Section 2. It also incorporates addenda issued since the publication of the 1997 edition and appropriate updates to referenced standards.

**The installation of measures in accordance with this guidance is NOT a warranty that Radon levels will be reduced below the relevant National Reference Level. It is recommended to have the Radon level assessed when the building is in use and again after remediation action, should such prove necessary.**

#### Transitional Arrangements

In general, this document applies to works commencing on or after 1st April 2005.

Technical Guidance Document C - SITE PREPARATION AND RESISTANCE TO MOISTURE, dated 1997, also ceases to have effect from that date. However, the latter document may continue to be used in the case of works, where the works commence on or before 31 March 2005.

#### The Guidance

The materials, methods of construction, standards and other specifications (including technical specifications) which are referred to in this document are those which are likely to be suitable for the purposes of the Regulations. Where works are carried out in accordance with the guidance in

this document, this will, prima facie, indicate compliance with Part C of the Second Schedule to the Building Regulations. However, the adoption of an approach other than that outlined in the guidance is not precluded provided that the relevant requirements of the Regulations are complied with. Those involved in the design and construction of a building may be required by the relevant building control authority to provide such evidence as is necessary to establish that the requirements of the Building Regulations are being complied with.

#### Existing Buildings

In the case of material alterations or changes of use of existing buildings, the adoption without modification of the guidance in this document may not, in all circumstances, be appropriate. In particular, the adherence to guidance, including codes, standards or technical specifications, intended for application to new work may be unduly restrictive or impracticable. Protected structures, proposed protected structures and other buildings of architectural or historical interest are especially likely to give rise to such circumstances. In these situations, alternative approaches based on the principles contained in the document may be more relevant and should be considered.

#### Technical Specifications

Building Regulations are made for specific purposes, e.g. to provide, in relation to buildings, for the health, safety and welfare of persons in and about buildings, the conservation of energy and access for people with disabilities. Technical specifications (including harmonized European Standards, European Technical Approvals, National Standards and Agrément Certificates) are relevant to the extent that they relate to these considerations. Any reference to a technical specification is a reference to so much of the specification as is relevant in the context in which it arises. Technical specifications may also address other aspects not covered by the Regulations.

A reference to a technical specification is to the latest edition (including any amendments, supplements or addenda) current at the date of publication of this Technical Guidance Document. However, if this version of the technical specification is subsequently revised or updated by the issuing body, the new version may be used as a source of guidance provided that it continues to address the relevant requirements of the Regulations.

---

## **Materials and Workmanship**

Under Part D of the Second Schedule to the Building Regulations, building work to which the Regulations apply must be carried out with proper materials and in a workmanlike manner. Guidance in relation to compliance with Part D is contained in Technical Guidance Document D.

## **Interpretation**

In this document, a reference to a section, subsection, part, paragraph or diagram is, unless otherwise stated, a reference to a section, subsection, part, paragraph or diagram, as the case may be, of this document. A reference to another Technical Guidance Document is a reference to the latest edition of a document published by the Minister for the Environment under article 7 of the Building Regulations, 1997. Diagrams are used in this document to illustrate particular aspects of construction - they may not show all the details of construction.

# Site Preparation and Resistance to Moisture

---

## Building Regulations - The Requirement

Part C of the Second Schedule to the Building Regulations, 1997, provides as follows:

Preparation of site.	C1	The ground to be covered by a building shall be reasonably free from vegetable matter.
Subsoil drainage.	C2	Subsoil drainage shall be provided if necessary so as to prevent the passage of ground moisture to the interior of the building or damage to the fabric of the building.
Dangerous substances.	C3	Reasonable precautions shall be taken to avoid danger to health and safety caused by substances (including contaminants) found on or in the ground to be covered by a building.
Resistance to weather and ground moisture.	C4	The floors, walls and roof of a building shall be so designed and constructed as to prevent the passage of moisture to the inside of the building or damage to the fabric of the building.
Definitions for this Part.	C5	<p>In this Part -</p> <p>“contaminant” includes any substance which is or could become flammable, explosive, corrosive, toxic or radioactive and any deposits of faecal or animal matter;</p> <p>“floor” includes any base or structure between the surface of the ground or the surface of any hardcore laid upon the ground and the upper surface of the floor and includes finishes which are laid as part of the permanent construction;</p> <p>“moisture” includes water vapour and liquid water.</p>

This Technical Guidance Document is divided into three sections.

Section 1 relates to the Requirements C1 and C2.

Section 2 relates to the Requirement C3.

Section 3 relates to the Requirement C4 and is divided into three sub-sections:

- (a) Sub-section 3.1 deals with floors next to the ground;
- (b) Sub-section 3.2 deals with walls;
- (c) Sub-section 3.3 deals with cladding for external walls and roofs.



# Section 1

## Site Preparation and Site Drainage

---

Preparation of site.	C1	The ground to be covered by a building shall be reasonably free from vegetable matter.
Subsoil drainage.	C2	Subsoil drainage shall be provided if necessary so as to prevent the passage of ground moisture to the interior of the building or damage to the fabric of the building.

**1.1** Relevant guidance is contained in CP 102 : 1973 Code of practice for protection of buildings against water from the ground and BS 8102 : 1990 Code of practice for protection of buildings against water from the ground, which partially replaces CP 102 : 1973. Relevant guidance is also contained in I.S. EN 752 Part 1-4 : Drain and Sewer Systems outside Buildings

**1.2** The following paragraphs (1.3 to 1.9) give some guidance on good practice insofar as it relates to non-complex buildings of normal design and construction.

### Organic Material

**1.3** Turf and other vegetable matter should be removed from the ground to be covered by the building at least to a depth sufficient to prevent later growth.

**1.4** Where the ground to be covered by the building contains tree roots or readily compressible material (even if it contains no organic material) which could affect the stability of the building, building services (such as below ground drainage) should be sufficiently robust or flexible to resist or accommodate movement. Joints should be made so that roots will not penetrate them.

### Site Drainage

**1.5** The guidance which follows assumes that the site of the building is not subject to flooding or, if it is, that appropriate steps are being taken.

**1.6** The water table is likely to be high where the ground is damp in dry weather, where the type of vegetation indicates damp ground, or where the site of the building is surrounded by higher ground.

**1.7** Where the extent of ground water could affect the stability of the building, or where the water table can rise to within 250 mm of the lowest floor of the building, either the ground to be covered by the building should be drained by gravity or other effective means of safeguarding the building should be taken. Where surface water could enter or adversely affect the building, appropriate measures should be taken.

**1.8** If an active subsoil drain is cut during excavation, the following steps should be taken (see Diagram 1):

- (a) if it is to pass through the building, it should be relaid in pipes with sealed joints and have access points outside the building, or
- (b) it should be diverted around the building, or
- (c) it should be diverted to another outfall.

Where new subsoil drainage is required, it should be provided as illustrated in Diagram 2.

**1.9** As an alternative to providing or rerouting subsoil drainage, and where adequate measures are taken to ensure structural stability (see Technical Guidance Document A), additional measures may be taken to prevent the passage of ground moisture to the inside of the building, or parts of the fabric of the building, which would be adversely affected (see Requirement C4).

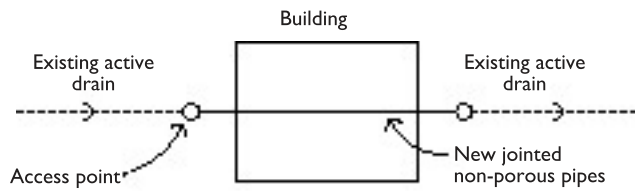

(a) SINGLE DRAIN RE-LAID UNDER BUILDING

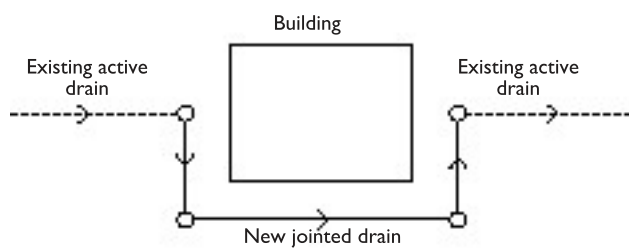

(b) SINGLE DRAIN DIVERTED

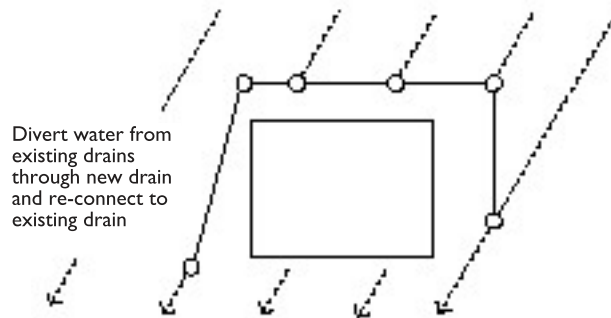

(c) MORE THAN ONE DRAIN DIVERTED

**Investigation of Site**

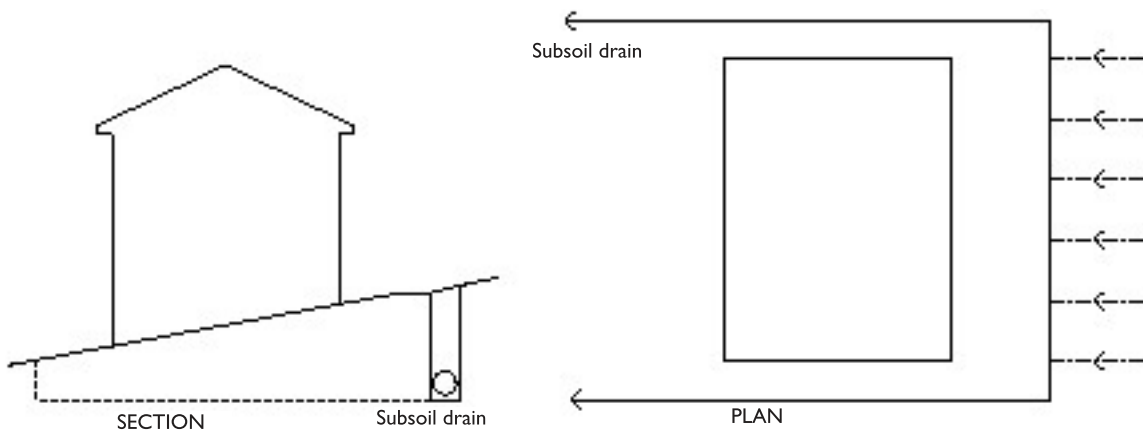

# Section 2

## Dangerous Substances

Dangerous substances. C3 Reasonable precautions shall be taken to avoid danger to health and safety caused by substances (including contaminants) found on or in the ground to be covered by a building.

Definition for this Part. In this Part - "contaminant" includes any substance which is or could become flammable, explosive, corrosive, toxic or radioactive and any deposits of faecal or animal matter;

**2.1** The ground to be covered by a building includes the ground to be covered by its foundations.

**2.2** In all cases, appropriate site investigations should be undertaken to check for the presence of contaminants. Contamination may arise from sources outside of the site e.g. landfill (see par. 2.18).

**2.3** As a preliminary measure, investigation of previous uses of a site should be considered, e.g. from local knowledge or by examination of local authority planning records. Examples of sites which are particularly likely to have been contaminated by their past or present uses are given in Table 1. Some signs of the possible presence of contaminants are given in Table 2.

**2.4** Detailed guidance on the identification and investigation of sites is contained in BS 5930 : 1999 (see also par. 2.18).

### Remedial Measures

**2.5** If the presence of contaminants is confirmed, appropriate remedial action should be undertaken and, except in the case of Radon, (see par. 2.7), the local authority should be informed.

**2.6** Where the most hazardous conditions arise, only the total removal of contaminants can provide a complete remedy. In other cases, alternative measures may reduce the risks to acceptable levels. Where there is a risk of gas accumulating, appropriate measures must be taken in the design and construction of the building. In all cases, action should only be undertaken with the benefit of expert advice.

**Table 1 Sites likely to contain contaminants**

- Asbestos works
- Chemical works
- Gas works, coal carbonisation plants and ancillary by-product works
- Industries making or using wood preservatives
- Landfill and other waste disposal sites or ground within 250 metres of such sites
- Metal mines, smelters, foundries, steel works and metal finishing works
- Oil storage and distribution sites
- Paper and printing works
- Railway land, especially the larger sidings and depots
- Scrap yards
- Sewage works, sewage farms and sludge disposal sites
- Tanneries

**Table 2 Possible contaminants**

Signs of possible contamination	Possible contaminant
(a) Vegetation (absence of, poor or unnatural growth)	metals, metal compounds, organic compounds, gases
(b) Surface materials (unusual colours and contours may indicate wastes and residues)	metals, metal compounds, oily and tarry wastes, asbestos (loose), other fibres, organic compounds (including phenols), potentially combustible material including coal and coke dust, refuse and waste
(c) Fumes and odours (may indicate organic chemicals at very low concentrations)	flammable, explosive and asphyxiating gases, including methane and carbon dioxide, corrosive liquids, faecal, animal and vegetable matter (biologically active)
(d) Drums and containers (whether full or empty)	various

---

## Radon

**2.7** Radon is a naturally occurring radioactive gas. It enters buildings from the underlying soil and in certain cases can accumulate in a building to such a concentration that it is deemed to constitute a potential health hazard. Radon is deemed to be a risk factor for lung cancer, particularly for smokers.

The National Reference Level (NRL) for long-term exposure to Radon in **Dwellings** is 200 Becquerels per cubic metre, or **200Bq/m<sup>3</sup>**. Above this level the need for remedial action should be considered.

The Radiological Protection Act, 1991 (Ionising Radiation) Order 2000 (SI No. 125 of 2000) - referred to as the "ionising radiation order"- implements the Euratom Basic Safety Standards Directive - Council Directive 96/26/Euratom. This sets a National Reference Level (NRL) for Radon Gas in **Workplaces** of **400Bq/m<sup>3</sup>** averaged over any three months. Above this level the employer is required to determine if remedial action is justified.

SI No. 125 of 2000 gives power to the Radiological Protection Institute of Ireland (RPII) to direct persons responsible for workplaces to measure Radon levels in their workplace.

**2.8** It is not possible to accurately predict the concentration of indoor Radon likely to occur in a proposed building on the basis of a pre-construction site investigation.

The Radiological Protection Institute of Ireland (RPII) has published the results of a national survey of Radon levels in existing houses, Radon in Dwellings – The Irish National Radon Survey. From this survey, it was estimated that some 91,000 houses, or 7% of the total housing stock had Radon gas concentrations above the NRL for dwellings.

Based on the results of the survey the RPII have identified **High Radon Areas** – where it is predicted that more than 10% of dwellings in the area will have Radon gas concentrations above 200Bq/m<sup>3</sup>. However, houses with high concentrations of Radon gas are not confined to these areas and can occur in individual dwellings in any part of the country.

**Maps** showing the estimated percentage of houses above the National Reference Level for dwellings for each 10km grid square are presented in *Maps 1 to 5* at the end of this section, with the kind permission of the RPII. Any queries in relation to these maps should be directed to the RPII. The RPII can be contacted at 3 Clonskeagh Square, Clonskeagh Road, Dublin 14, Tel 01-2697766 or at [www.rpii.ie](http://www.rpii.ie)

**2.9** Measures can be taken during the design and construction of a building which will significantly reduce the risk of Radon concentrations in excess of the NRL and will provide a potential means of remediation, which can be activated at low cost and with little disruption, should Radon concentrations be found to be excessive when the building is in use. Appropriate measures are outlined in the following paragraphs.

### 2.10 Dwellings or other long-stay residential buildings

- (a) **High Radon Areas:** measures should be taken to protect the building from Radon in the ground. For example, in the case of a non-complex building of normal design and construction, a fully sealed membrane of low permeability over the entire footprint of the building and a potential means of extracting Radon from the substructure such as a standby Radon sump or sumps with connecting pipework or other appropriate certified systems should be provided.
- (b) **Areas other than High Radon Areas:** the building should be provided with a potential means of extracting Radon from the substructure should that prove necessary after construction. For example, in the case of a non-complex building of normal design and construction, the provision of a standby Radon sump or sumps with connecting pipework or other appropriate certified systems should be adequate.

### 2.11 Other Buildings

The designer should consider the provision of measures to protect buildings against high Radon concentrations. In the absence of specific guidance, provisions similar to those in 2.10 may be adopted.

**2.12 Membranes** used for Radon protection should be appropriate for this use. In the absence of specific standards governing products for this purpose, the fitness of the membrane should be established by independent certification by an approved body e.g. by the NSAI Irish Agreement Board. The parameters certified should include those in Table 3. Table 3 identifies parameters, tests and minimum performance levels for Low Density

Polyethylene (LDPE) membranes. Tests may vary for non-LDPE materials, however performance levels to be achieved should be equivalent to those identified for LDPE in Table 3.

Membranes used for Radon protection will normally be provided in lieu of the damp-proof membranes described in Section 3 of this document.

<b>Table 3 Minimum Performance Level for LDPE Radon Proof Membranes</b>		
<b>Parameter</b>	<b>Test</b>	<b>Performance Level</b>
Radon Permeability	Laboratory Test with Radon Gas – Rn 222	$12 \times 10^{-12} \text{m}^2/\text{s}$
Tensile Strength	I.S. EN 12311-2:2000 or IS EN ISO 527-3	MD > 12Mpa CD > 12Mpa
Elongation	I.S. EN 12311-2:2000 or I.S. EN ISO 527-3	$\geq 100\%$ (at break) Un-reinforced LDPE $\geq 12\%$ (at max. load) Reinforced LDPE
Tear Resistance	I.S. EN 12310-2:2000	>100N
Moisture Vapour Resistance	BS 3177	>50MNs/g
Low Temperature Flexibility	I.S. EN 495-5:2000	No cracking at -25 deg C

**2.13 Particular care should be taken when installing the membrane.** All joints and service penetrations must be fully sealed. In view of the difficulty of achieving gas-tight seals under site conditions, it is recommended that the membrane be prefabricated and installed by appropriately trained personnel.

**2.14 Every precaution must be taken to protect the membrane** from damage, pre- and post- installation and also during its lifetime including making appropriate allowances for differential settlement.

**2.15** Advice on design, location, and number of **standby Radon sumps** along with design of associated pipework is contained in “Radon in Existing Buildings – Corrective Options” (2002). A single

sump is likely to have influence over an area of at least  $250\text{m}^2$  and for a distance of at least 15m from the sump. The hardcore layer should be clean, dry, well-compacted and gas permeable following the compaction process.

Obstructions below the floor slab may reduce the effectiveness of the standby Radon sump system when activated. Accordingly, it may be necessary to provide perforations in the rising walls or separate standby Radon sumps with interconnecting pipework in each compartment.

---

**The pipework from standby Radon sumps, should terminate and be capped** either above ground level externally, or in the attic space. Externally, pipes should be provided with sealed caps - to prevent ingress of rainwater or rodents.

**Pipe terminals should be clearly marked** to indicate the function of the pipework system to facilitate later activation should this prove necessary and also prevent misuse. For example, a marker plate may be erected on a permanent structure adjacent to the pipe terminal, or a pipe cap incorporating raised lettering may be used.

By extending the pipework and installing and activating a fan, the standby Radon sump system becomes a sub floor gas extraction system. The terminal should be located so that the pipework and fan can be practically fitted, without causing unnecessary obstruction.

**2.16 The installation of measures in accordance with this guidance is NOT a warranty that Radon concentration levels will be reduced below the relevant National Reference Level. Building owners are recommended to have the Radon concentration level assessed when the building is in use and again after remediation action, should such prove necessary.**

**2.17** Information on the procedure to assess Radon concentration levels in occupied dwellings or workplaces can be obtained from the RPII or from other Radon measurement service providers.

For Radon surveys in workplaces refer to RPII's publication "Planning Radon Surveys in Workplaces – Guidance Notes" (May 2004).

## **Landfill Gas**

**2.18** Guidance on the appropriate measures to be taken in the design and construction of buildings on or near sites containing landfill is provided in the Department's publication "Protection of New Buildings and Occupants from Landfill Gas".

# Map 1 Index Map of Ireland

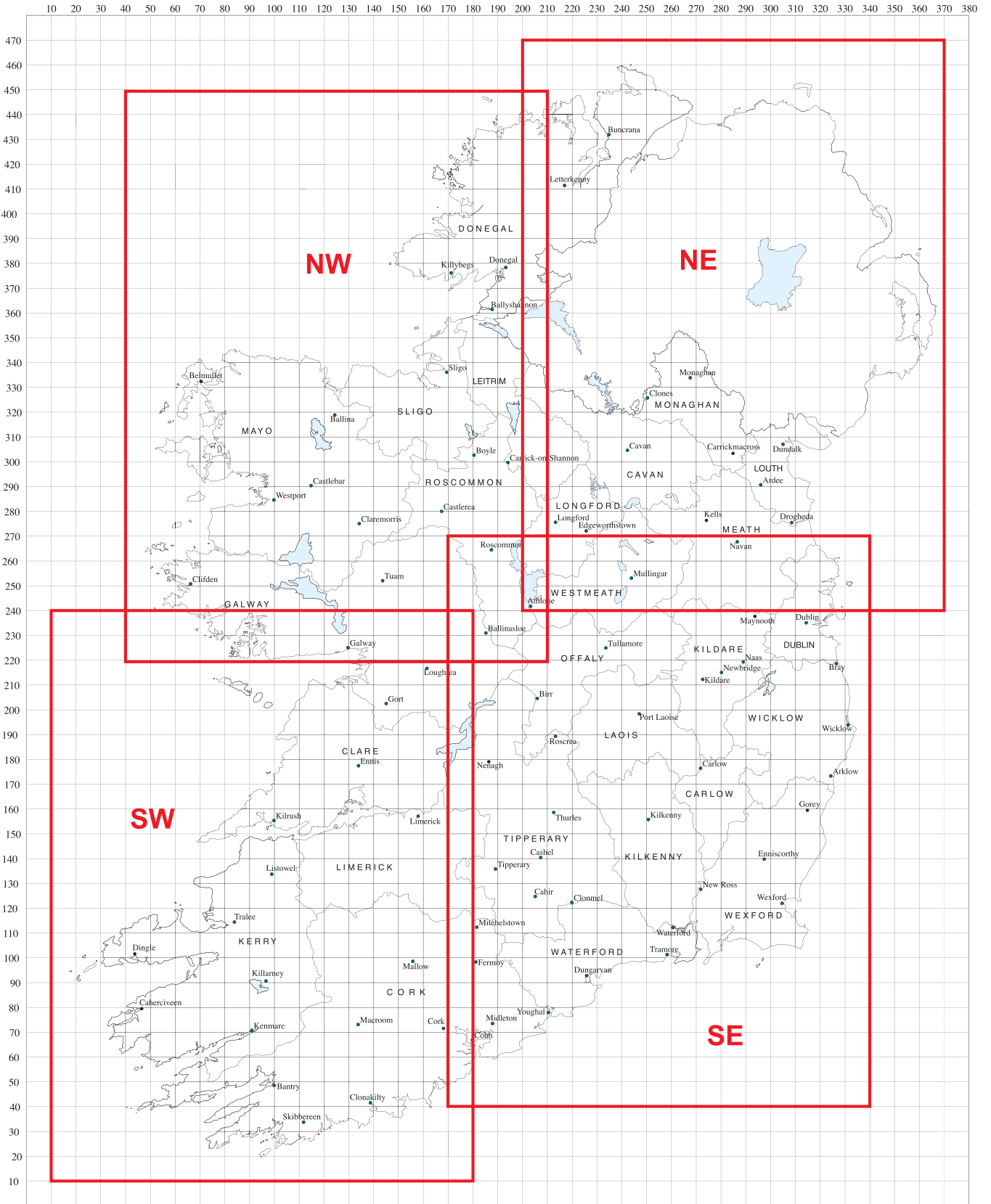

# Map 2 Radon Prediction Map for the North West of Ireland

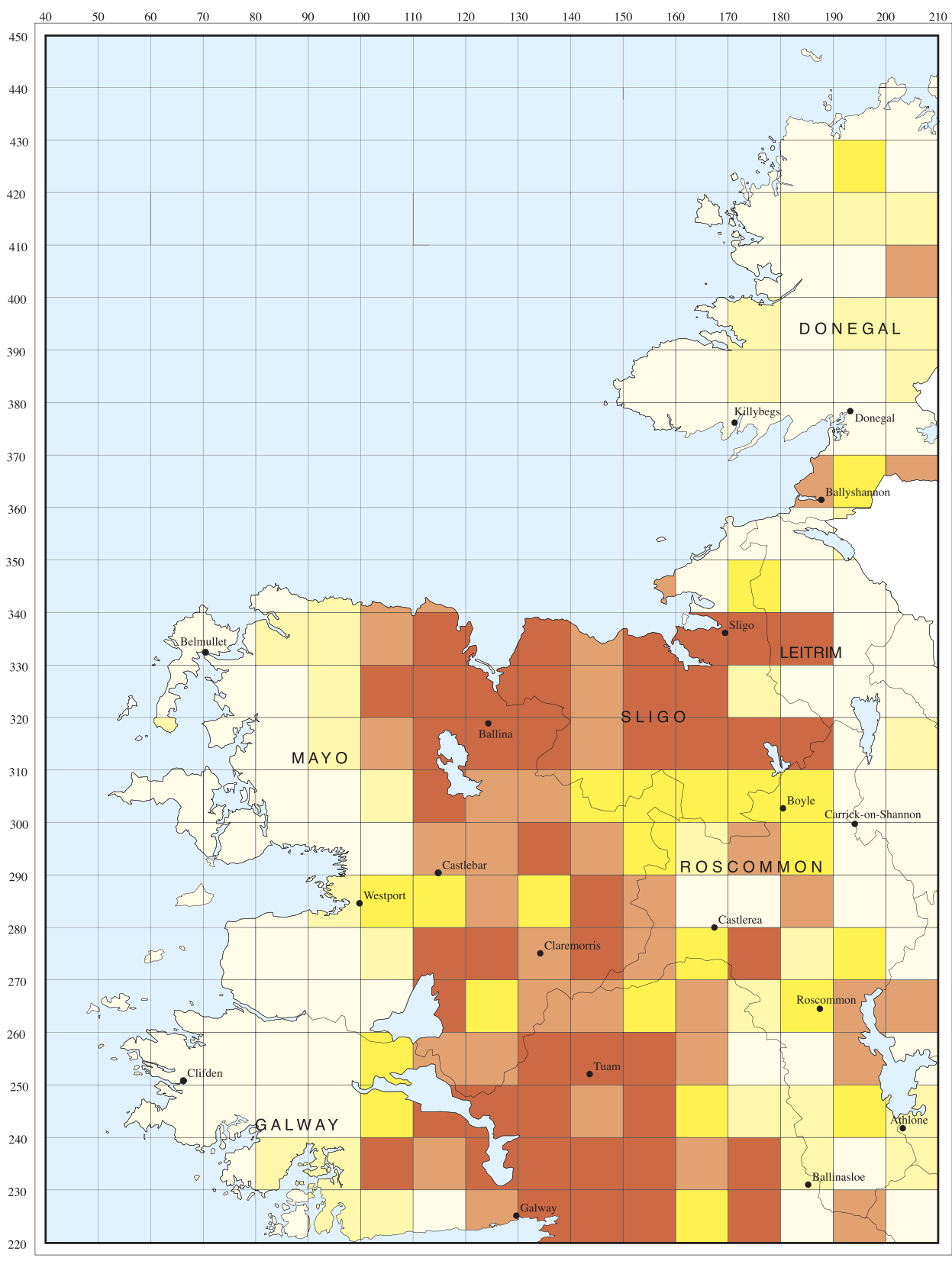

Estimated Percentage of Dwellings above 200 Bq/m<sup>3</sup>

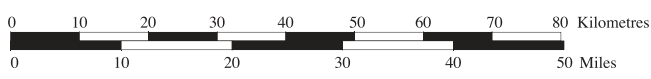
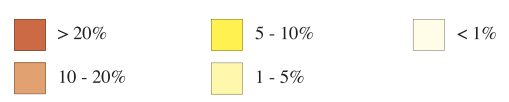



# Map 3 Radon Prediction Map for the North East of Ireland

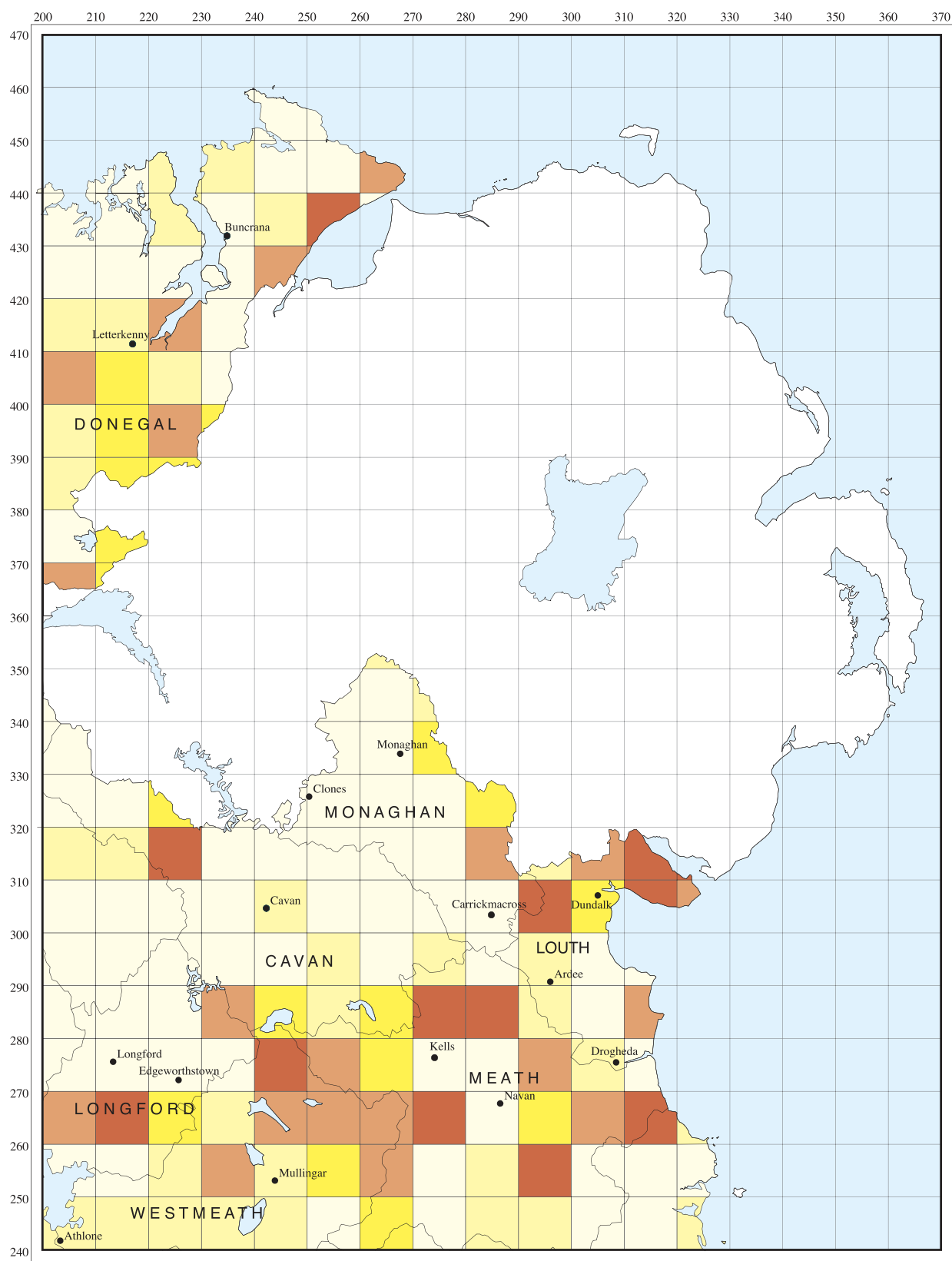

**Estimated Percentage of Dwellings above 200 Bq/m<sup>3</sup>**

<span style="display: inline-block; width: 15px; height: 15px; background-color: #8B4513; border: 1px solid black;"></span> > 20%	<span style="display: inline-block; width: 15px; height: 15px; background-color: #FFD700; border: 1px solid black;"></span> 5 - 10%	<span style="display: inline-block; width: 15px; height: 15px; background-color: #FFFACD; border: 1px solid black;"></span> < 1%
<span style="display: inline-block; width: 15px; height: 15px; background-color: #D2691E; border: 1px solid black;"></span> 10 - 20%	<span style="display: inline-block; width: 15px; height: 15px; background-color: #FFDAB9; border: 1px solid black;"></span> 1 - 5%	

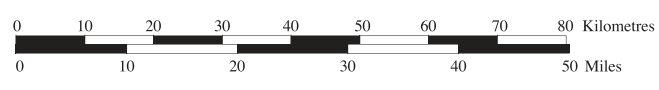

# Map 4 Radon Prediction Map for the South West of Ireland

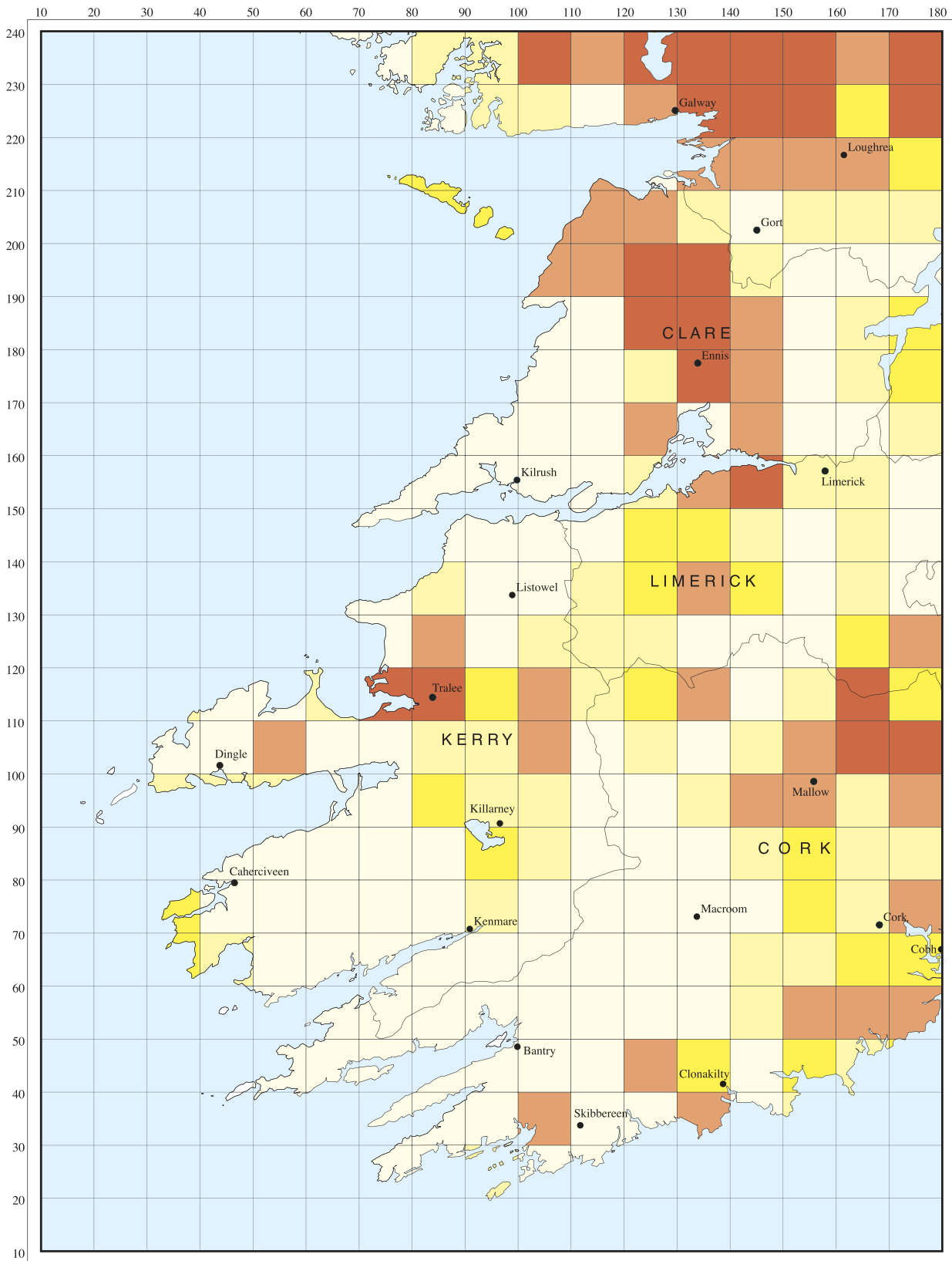

**Estimated Percentage of Dwellings above 200 Bq/m<sup>3</sup>**

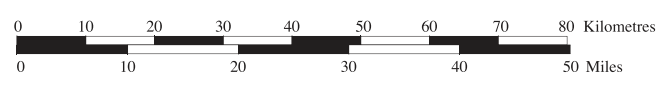
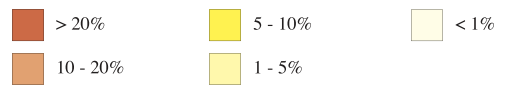

## Map 5 Radon Prediction Map for the South East of Ireland

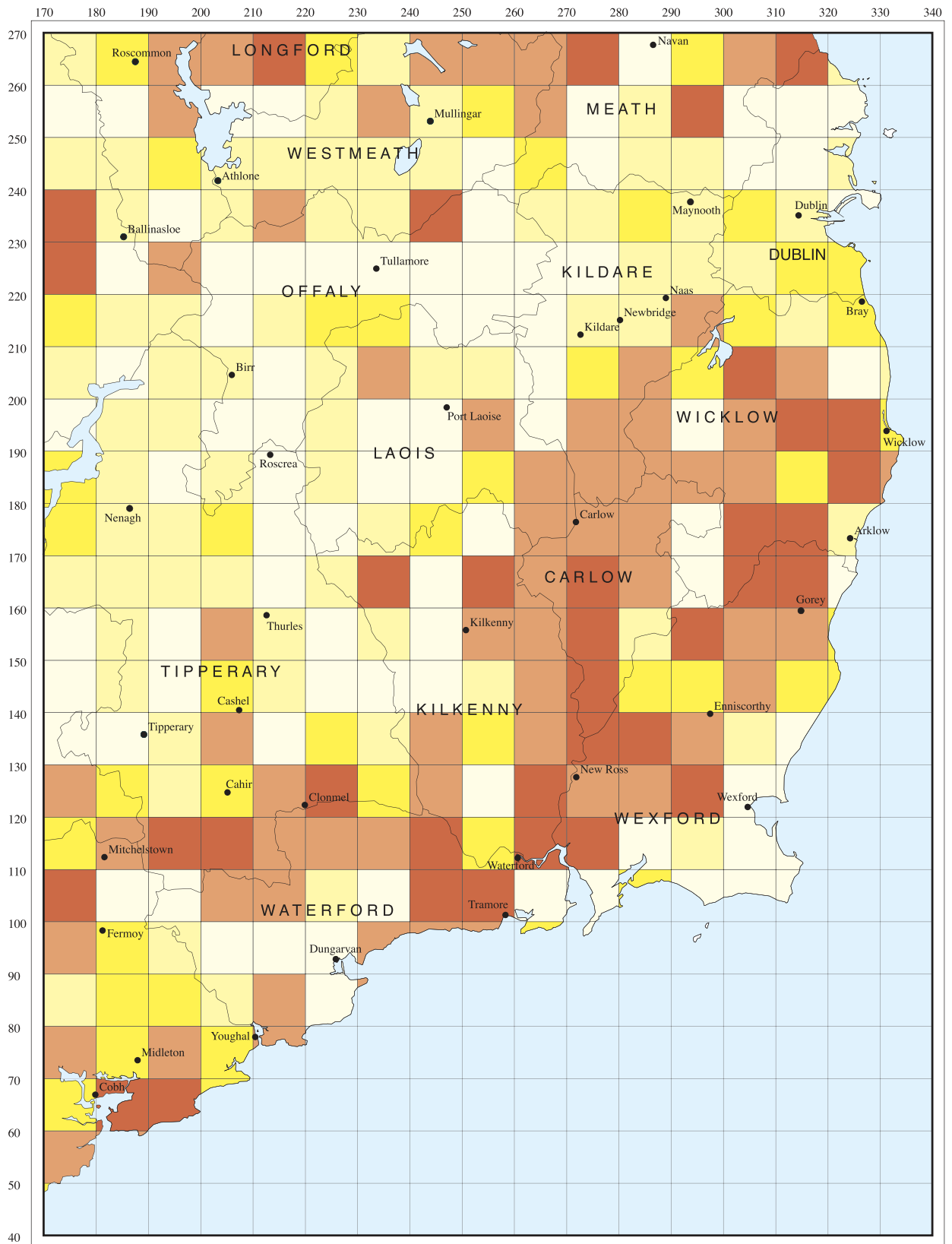

Estimated Percentage of Dwellings above 200 Bq/m<sup>3</sup>

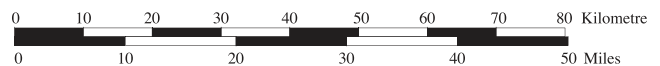
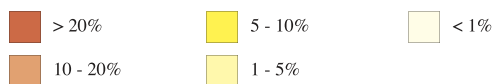

Source: Radiological Protection Institute of Ireland. February 2002 Radon in Dwellings. The Irish National Radon Survey.

# Section 3

## Resistance to Weather and Ground Moisture

Resistance to weather and ground moisture.	C4	The floors, walls and roof of a building shall be so designed and constructed as to prevent the passage of moisture to the inside of the building or damage to the fabric of the building.
Definitions for this Part.		In this Part - "floor" includes any base or structure between the surface of the ground or the surface of any hardcore laid upon the ground and the upper surface of the floor and includes finishes which are laid as part of the permanent construction;  "moisture" includes water vapour and liquid water;

### Introduction

**3.0.1** There are several references in this Section to moisture damage. The damage in question is damage so serious that it would produce deterioration in a material or structure to the point that it would present a danger to health or safety or (if it is an insulating material) that its performance would be substantially and permanently reduced.

**3.0.2** Damage can be avoided either by preventing moisture from reaching materials which would be damaged or by using materials which will not be damaged by moisture.

### Sub-section 3.1 Floors next to the Ground

**3.1.1** A floor next to the ground should:

- (a) prevent ground moisture from reaching the upper surface of the floor (see Diagram 3); and
- (b) not be damaged by moisture from the ground.

**3.1.2** Guidance in relation to dealing with moisture from the ground is contained in clause 11 of CP 102 : 1973 and in BS 8215 : 1991.

**3.1.3** The following paragraphs (3.1.4 to 3.1.10) give some guidance on good practice insofar as it relates to non-complex buildings of normal design and construction.

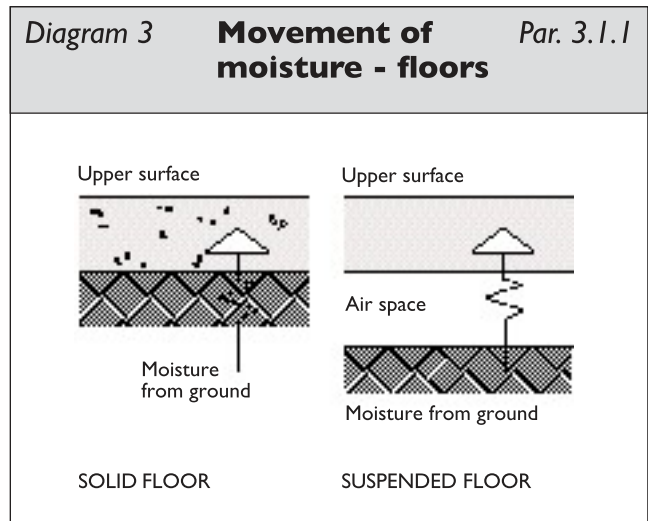

### Ground Supported Floors

**3.1.4** A ground supported floor, unless it is liable to be subject to ground water pressure, should be constructed of dense concrete laid on a hardcore bed and incorporate a damp proof membrane as follows (see Diagram 4):

- (a) The concrete should be at least 150 mm thick (but thicker if the structural design requires) and be composed of cement (type CEM1) to I.S. EN 197 – 1 2001 and fine and coarse aggregate conforming to I.S. EN 12620: 2002: Aggregates for Concrete; and be
  - (i) reinforced concrete of a grade of concrete in accordance with I.S. EN 206-1:2002 (including the Irish National Annex) or
  - (ii) unreinforced concrete with a characteristic 28 day cube strength of 20

N/mm<sup>2</sup>, a minimum cement content of 200 kg/m<sup>3</sup> and a maximum water cement ratio of 0.85 (when volumetric mixing is required for small projects, a 1:7 cement aggregate mix may be used).

- (b) The hardcore bed should be at least 150 mm thick. Hardcore should conform with I.S. EN 13242:2002 and meet the specification as outlined in Annex E of the accompanying guidance document to this standard, SR21: 2004+A1: 2007. The layer of hardcore should be well compacted, clean and free from matter liable to cause damage to the concrete. Specific guidance is given in 3.4.2 of SR21: 2004+A1: 2007 on limiting the presence of a reactive form of pyrite which may give rise to swelling or sulfate attack on concrete.

A blinding layer should be provided in accordance with the specification given in Annex E, of SR21: 2004+A1: 2007, for fines material. The blinding layer should be of adequate depth to fill surface voids thus creating an even surface and avoiding sharp projections, which may damage radon or damp-proof membranes. (Amendment C (i))

- (c) The damp-proof membrane may be located above or below the concrete, and should be continuous with the damp-proof courses in walls (see Diagram 5).

**3.1.5** A damp-proof membrane laid below the concrete should be at least 300 µm (1200 gauge), laid with the joints sealed as prescribed in CP 102 on a bed of blinding material which will not damage the sheet.

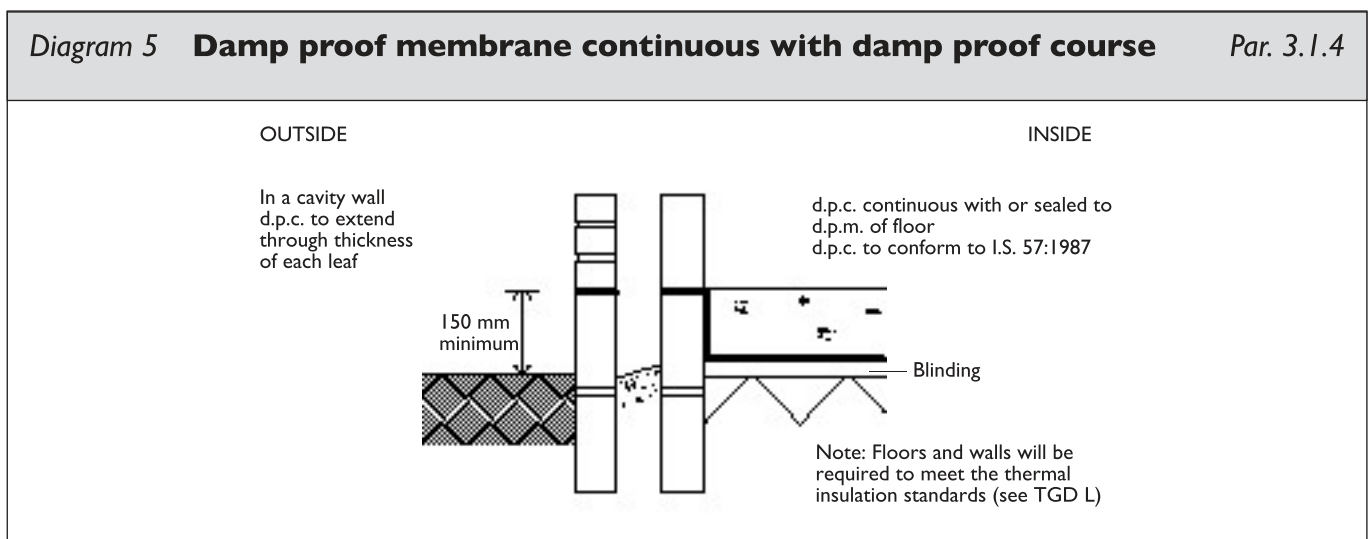
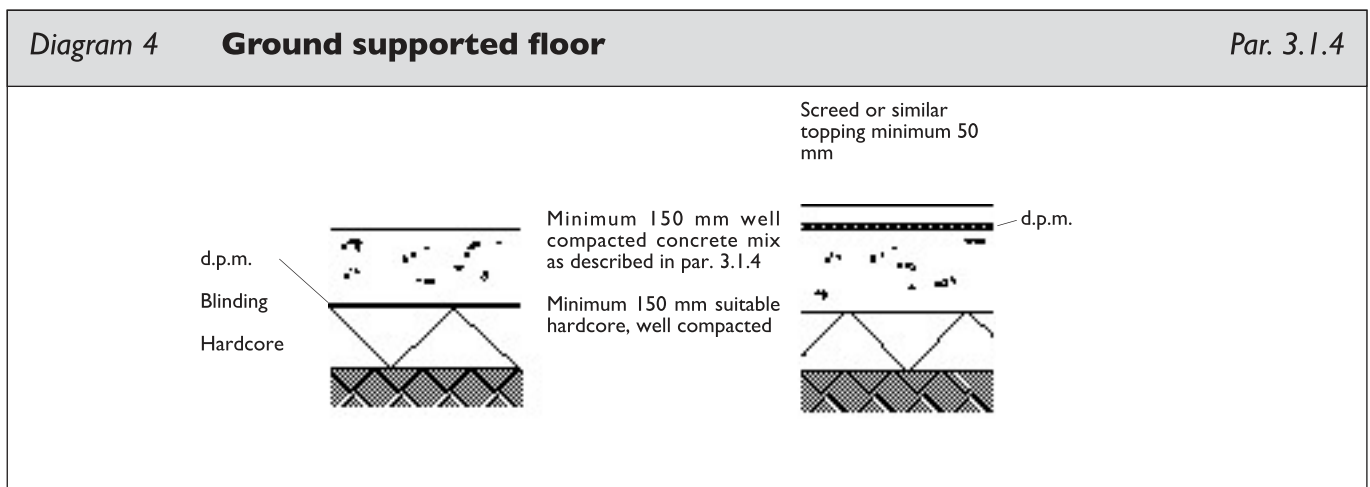

**3.1.6** A damp-proof membrane laid above the concrete should be either polythene sheet as described in par. 3.1.5 (but without the blinding material) or three coats of cold applied bitumen solution or similar moisture and water-vapour resisting material. In each case, the membrane should be protected by either a screed or a floor finish unless it is pitchmastic or similar material intended to serve as a floor finish.

**3.1.7** A timber floor finish laid directly on concrete may be bedded in a material which may also serve as a damp-proof membrane. Timber fillets laid in the concrete as a fixing for a floor finish should be treated with an effective preservative. Some preservative treatments are described in BS 1282 : 1999 (see Diagram 6).

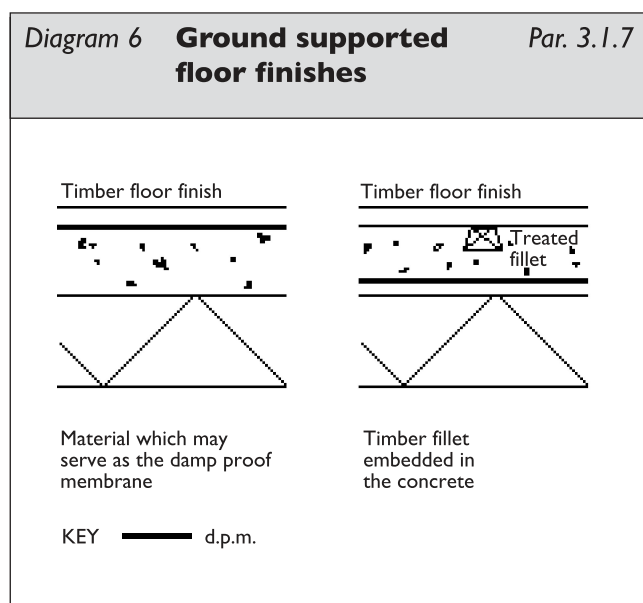

## Suspended Timber Ground Floors

**3.1.8** A suspended timber floor next to the ground should be built as follows (see Diagram 7):

- (a) The ground should be covered in concrete at least 100 mm thick and composed of concrete grade as described in par. 3.1.4(a). The concrete should be laid on a hardcore bed at least 100 mm thick of broken stones, broken brick or similar suitable material, well compacted and clean and free from matter liable to cause damage to the concrete. The concrete should be so laid that its top surface is not below the highest level of the surface of the ground or paving adjoining any external wall of the building.
- (b) There should be a ventilated air space measuring at least 75 mm from the concrete to the underside of any wall plates and at least 150 mm to the underside of the suspended timber floor (or insulation if provided). Each external wall should have ventilation openings placed so that the ventilating air will have a free path between opposite sides and to all parts. The openings should be large enough to give an actual opening of at least equivalent to 1500 mm<sup>2</sup> for each metre run of wall. Any pipes needed to carry ventilating air should have a diameter of at least 100 mm.

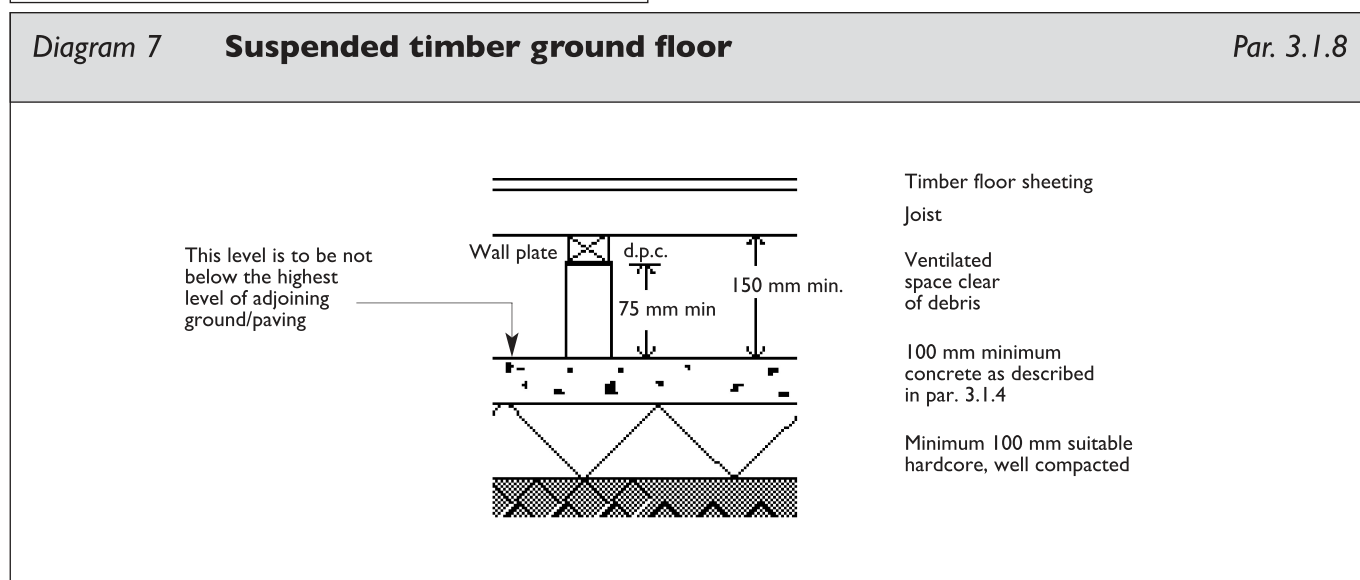

- (c) There should be a damp-proof course conforming to I.S. 57:1987, BS 743, BS 6398, BS 6515, BS 8215 or CP 102 provided in such positions as to ensure that moisture from the ground cannot reach any timber or other material which would be adversely affected by it.

## Suspended Concrete Ground Floors

**3.1.9 Suspended concrete ground floor with ventilated voids** - This type of floor should be built:

- (a) using in-situ concrete or precast concrete (with or without infilling slabs) at least 100 mm thick (but thicker if the structural design requires) and of a grade described in par. 3.1.4(a), incorporating a damp-proof membrane as necessary, and
- (b) with a ventilated air space measuring at least 150 mm clear from the ground to the underside of the floor, and
- (c) with ventilation openings in each external wall placed so that the ventilating air will have a free path between opposite sides and to all parts. The opening should be large enough to give an actual opening of at least equivalent to 1500 mm<sup>2</sup> for each metre run of wall.

*Note:*

Sub-paragraphs (b) and (c) apply where there is a risk of explosive gas mixtures accumulating in voids under the floor. The height of the ventilated air space may be reduced where proprietary void formers are used.

**3.1.10 Suspended concrete ground floor cast on the ground** - This type of floor should be built using in-situ concrete at least 100 mm thick (but thicker if the structural design requires) and of a grade described in par. 3.1.4(a), incorporating a damp-proof membrane as necessary.

*Note:*

This form of construction should only be used where it is unlikely that a substantial gap will form under the suspended floor due to the settlement of the ground

under its own weight, thereby creating a risk of explosive gas mixtures accumulating under the floor.

## Sub-section 3.2 Walls

**3.2.1** All walls should:

- (a) prevent moisture from the ground from reaching the inside of the building (see Diagram 8), and
- (b) not be damaged by moisture from the ground, and
- (c) not carry moisture from the ground to any part of the building which would be damaged by it.

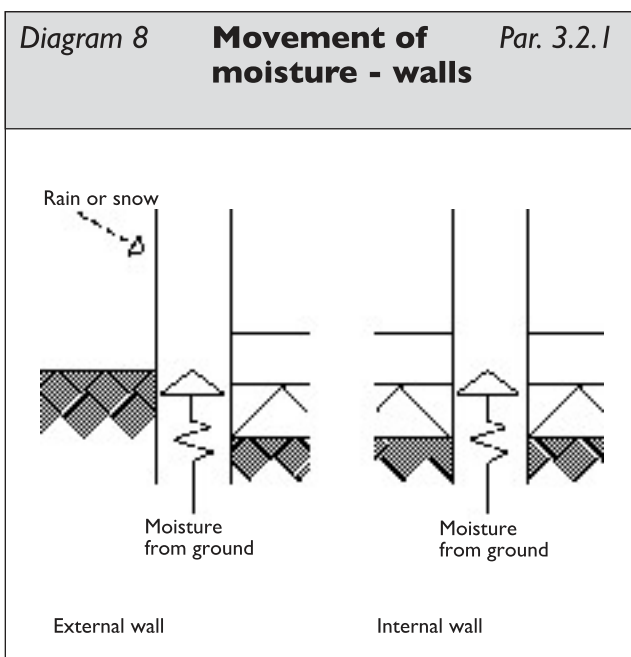

**3.2.2** External walls, in addition to meeting the requirements of par. 3.2.1, should:

- (a) resist the penetration of rain or snow to the inside of the building, and
- (b) not be damaged by rain or snow, and
- (c) not carry rain or snow to any part of the building which would be damaged by it.

### External and Internal Walls - Moisture from the Ground

**3.2.3** The following paragraphs give some guidance on good practice insofar as it relates to non-complex buildings of normal design and construction.

- (a) Walls should have a damp-proof course of bituminous material, engineering bricks or slates set in cement mortar or any other material that will prevent the passage of moisture. The damp-proof course should be continuous with the damp-proof membrane in the floors.
- (b) If the wall is an external wall, the damp-proof course should be at least 150 mm above the finished level of adjoining ground or paving (see Diagram 9).
- (c) If the wall is an external cavity wall, the cavity should be taken down at least 150 mm below the level of the lowest damp-proof course or a damp-proof tray should be provided so as to prevent rain or snow passing to the inner leaf.

**Diagram 9 External or internal wall** Par. 3.2.3

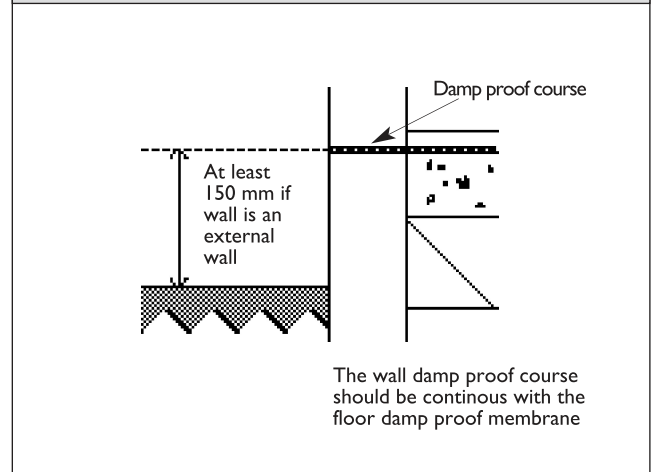

**3.2.4** BS8102 :1990 gives methods of preventing entry of ground and surface water into buildings from surrounding areas. BS 8215 : 1991 contains in clauses 4 and 5 recommendations for the selection, design and installation of damp proof courses in both solid and cavity masonry construction.

### External Walls - Moisture from Outside

**3.2.5** The following paragraphs (3.2.6 to 3.2.9) give some guidance on good practice insofar as it relates to non-complex buildings of normal design and construction.

**3.2.6** An external cavity wall may be constructed of two leaves with the outer leaf separated from the inner leaf by a drained air space or in any other way which will prevent moisture from the outside accumulating in the cavity or being carried to the inner leaf.

**3.2.7** An external cavity wall may be built as follows:

- (a) outer leaf of masonry (bricks, blocks, stone or cast stone), and
- (b) cavity at least 50 mm wide. The cavity should only be bridged by wall ties or by damp-proof trays provided to prevent moisture being carried to the inner leaf, and



- (c) inner leaf of masonry or frame with lining.

**3.2.8** An insulating material may be placed in the cavity between an outer leaf and inner leaf of masonry construction provided that -

- (a) where the cavity is to be filled, only insulating material which has been shown to satisfactorily prevent the passage of moisture to the inner leaf may be used, and
- (b) where the cavity is to be partially filled with insulating material, the residual cavity should be not less than 40 mm wide.

**3.2.9** For guidance regarding thermal insulation, refer to Technical Guidance Document L - Conservation of Fuel and Energy.

### Sub-section 3.3 Cladding (including Slating and Tiling) for External Walls and Roofs

**3.3.1** External walls and roofs should:

- (a) resist the penetration of rain or snow to the inside of the building,
- (b) not be damaged by rain or snow, and
- (c) not carry rain or snow to any part of the building which would be damaged by it (see Diagram 10).

**3.3.2** The following paragraphs (3.3.3 to 3.3.8) give some guidance on good practice insofar as it relates to non-complex buildings of normal design and construction.

**3.3.3** Cladding can be designed to protect a building from rain or snow (often driven by the wind) either by holding the rain or snow at the face of the building or by stopping it from penetrating beyond the back of the cladding (see Diagram 10).

*Diagram 10* **Cladding - walls and roofs** *Par. 3.3.1*

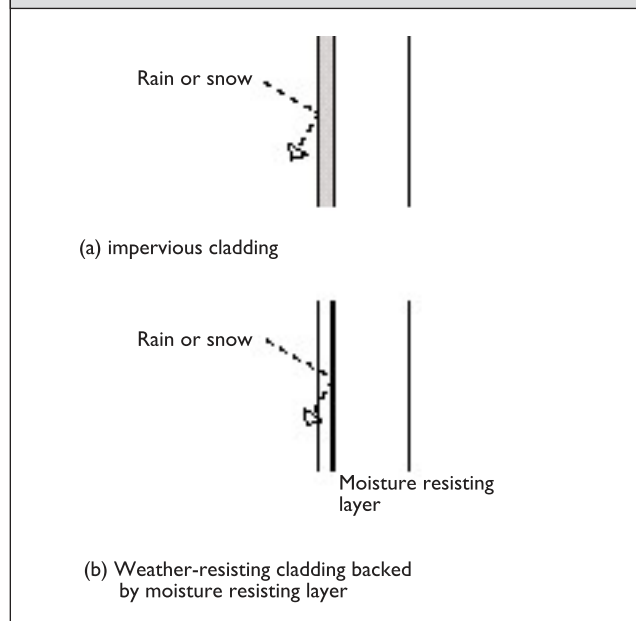

**3.3.4** Cladding should be adequate if:

- (a) it is jointless or has sealed joints, and is impervious to moisture (so that moisture will not enter the cladding), or
- (b) it has overlapping dry joints, is impervious or weather-resisting and is backed by a material which will direct rain or snow which enters the cladding towards the outside face.

**3.3.5** Some materials can deteriorate rapidly without special care and they should only be used as the weather-resisting part of a wall or roof if certain conditions are met (see Technical Guidance Document D - Materials and Workmanship).

The weather-resisting part of a wall or roof should not rely on paint or any coating or surface which does not provide all the weather-resistance.

**3.3.6** Cladding may be:

- (a) impervious, including metal, plastics, glass and bituminous products, or
- (b) weather-resisting, including natural stone or slate, cement based products, fired clay and wood, or

- 
- (c) moisture-resisting, including bituminous and plastics products, lapped if used as a sheeting material .

*Notes:*

- (i) Material should be permeable to water vapour unless there is a ventilated space directly behind the material. Ventilated spaces behind cladding materials may require cavity barriers and fire stopping. In such cases, reference should be made to Technical Guidance Document B - Fire Safety.
- (ii) Jointless materials and sealed joints should allow for structural and thermal movement.

**3.3.7** Dry joints between cladding units should be designed so that rain or snow will not pass through them. Alternatively, the cladding should be so designed that rain or snow which enters the joints will be directed towards the exposed face and will not penetrate beyond the back of the cladding.

*Note:*

Whether dry joints are suitable will depend on the design of the joint or the cladding and the severity of the exposure to wind and rain.

**3.3.8** Each sheet, tile and section of cladding should be securely fixed as prescribed in the appropriate standard or code.

# Standards and other references

---

I.S. 57: Part 1: 1987 Damp-Proof Courses, Part 1, Bitumen Damp-Proof Courses

I.S. 57: Part 2: 1987 Damp-Proof Courses, Part 2, Polyethylene Damp-Proof Courses

I.S. EN 197-1: 2001 Cement composition, Specifications & conformity criteria – Part 1 : common cements

I.S. EN 206 - 1: 2002 Concrete - Part 1: Specification, performance, production and conformity

I.S. EN 752 Part 1-4 Drain and Sewer Systems outside Buildings

I.S. EN 12620: 2002 Aggregates for Concrete

I.S. EN 13242:2002 Aggregates for unbound and hydraulically bound materials for use in civil engineering work and road construction

SR21: 2004+A1: 2007 Guidance on the use of I.S. EN 13242:2002 - aggregates for unbound and hydraulically bound materials for use in civil engineering work and road construction (Incorporating Amendment 1:2007). (*Amendment C (ii)*)

BS 743 : 1970 Specification for materials for damp proof courses AMD 2503; AMD 4336; AMD 4594; AMD 6579 (Partially Replaced by BS 6398, BS 6515, BS 8215)

BS 1282 : 1999 Wood preservatives, Guidance on choice, use and application

BS 5930 : 1999 Code of practice for site investigations

BS 6398 : 1983 Specification for bitumen damp-proof courses for masonry

BS 6515 : 1984 Specification for polyethylene damp-proof courses for masonry AMD 5444

BS 8102 : 1990 Code of practice for protection of structures against water from the ground

BS 8215 : 1991 Code of practice for design and installation of damp-proof courses in masonry

construction

CP 102 : 1973 Code of practice for protection of buildings against water from the ground AMD 1511; AMD 2196; AMD 2470 (Partially replaced by BS 8102 & BS 8215)

The Radiological Protection Act, 1991 (Ionising Radiation) Order, 2000, Statutory Instrument No.125 of 2000

“Radon in Existing Buildings –Corrective Options” published by the Department of the Environment, Heritage & Local Government (2002)

“Protection of New Buildings and Occupants from Landfill Gas” published by the Department of the Environment, Heritage and Local Government (1994)

“Radon in Dwellings – The Irish National Radon Survey” published by the Radiological Protection Institute of Ireland (2002)

“Planning Radon Surveys in Workplaces” published by the Radiological Protection Institute of Ireland (May 2004)